



Collins Walker

Incorporated

STOCK CATALOG 2026

"Our mission is to glorify God by working diligently, building relationships, striving for superior customer service, with a commitment to integrity"

**COLLINS WALKER INC
10900 GOODNIGHT LN. #130
DALLAS, TX 75220
972-247-5433
info@collinswalker.com**

Pricing is subject to change without notice. See Terms and Conditions.

Collins Walker Products	Description	Vendors
Access Doors (Duct)	Round, Rectangular, and Grease	Elgen, Nailor, Mason Road Sheet Metal
Access Panels (Dry Wall/Solid Surface)	Standard, Fire Rated, Stainless Steel, Stealth, and Fiberglass	Acudor, Babcock-Davis, Wind-Lock
Air Curtains		Mars
Conectric Diffusers and Plenum Drop Diffusers		Kees, Ruskin Rooftop Systems, Mason Road Sheet Metal
Constant Flow Regulators		Aldes, Nailor
Control Dampers and UL Listed		Nailor
Custom Metal Duct	Rectangular, Round, Oval, Aluminum, Stainless Steel, Double Wall, Paint Grip, Black Iron, Special Weild	Mason Road Sheet Metal
Duct Wrap (Insulation)		Certainteed Insulation
Dust Collectors		Sternvent
Exhaust/Supply Fans and Ventilation	Commerical, Residential, Direct Drive, EC Motor, Kitchen Related, Grease Duct, Axil, Industrial, Sidewall, Cage, Drum, Corrision Free, Roof Ventilation, Roof Curbs, Wall Caps, and Dryer Vents	Acme, Airpro, American Coolair, Captive-Aire, Patterson, Plastec Ventilation, Soler Palau, Fantech, Panasonic, Famco
Fabric Duct		Durkee Socks
Fan Filter Units		Nailor and AJ Manufacturing
Field Supplies	Screws, Air Seal, Brushes, Tap, Panduite Straps, Stailess Steel Strap with Worm-Gear, and Staples.	Elgen, Royal Metals, Ideal Tape, Polymer Adhesives
Filters (HEPA)		Joe Fly, AJ Manufacturing
Flex Duct	R6, R8, Acoustical, and Medium Pressure	Royal Metals, Peppertree, Thermaflex
Fume/Wielding Arms		Plymovent
Gas Detection		Acme Engineering, Brasch
Grille Accessories and Dampers	Radial Sliding Damper, Radial Blade Damper, Cable Operated Damper (In-Line), Molded Insulation Backs, Trim Frames, Square to Round and Round to Round Reducers.	Nailor
Grilles, Diffusers, and Registers	Commerical, Residential, Jet Nozzle, Custom Diffusers/Grilles, Stainless Steal, Critical Environment, Plastic, Architectural Grilles, Security Grilles, RGS Spiral Mounted, Clean Air, and Drum Louvers.	Air Concepts, AJ Manufacturing, American Louver Company, Kees, Linx Industries, Nailor, Softaire, Tuttle and Bailey, Airmate, Gun Aire, Hart & Cooley.
Hanging Supports for Duct/Equipment	Hanger Strap, Cable, Single Point, Double Point, Strut, All Thread, Bolts, Washers, Nuts, Drop-in Anchor, and Beam Clamps	Elgen, Gripple, Mason Road Sheet Metal
Heaters	Electric, Gas, Radiant, Duct Heaters	Advanced Radiant Systems, Markel, Modine, Nailor, Omark, Reznor, Warren Tech, Sterling Skyblade
HVLS Fans		Hydronic Components (HCI)
Hydronic Valve Kits		Construction Specialties, Nailor, Reliable
Louvers	Architectural, FEMA, and Custom	Captive-Aire, Rapid Engineering
Make-Up Air Units		Plymovent
Oil Mist Removal		ECO Foot, Mason Road Sheet Metal
Roof Support / Equipment Rails	Rubber Block, Quick Frame, Custom Equipment Rails	Elgen, Royal Metals, Mason Road Sheet Metal.
Round Pipe Elbows/Fittings/Pipe	Adjustable, Spiral, and Stamped Elbows. Snap-Lock Pipe, Inline Dampers, Taps with or without Dampers, Single Wall Spiral, Medium and Low Pressure Reducers.	Elgen
Shop Supplies	Slip, Drive, Corners, Cleats, J Angle, Flange, Rails, Turning Vanes, Handles, Rubber Bushings, Flex Connector, Wire Mesh, Butyl Gasket, Shrink Wrap, White Labels.	Air Products and Controls
Smoke Detectors		Acudor, Babcock-Davis, Bilco
Smoke Vents		Commercial Acoustics
Sound Attenuators		Nailor
Terminal Units	VAVs and Fan Powered Boxes	Plymovent
Vehicle Exhaust		Vibration Management Corp (VIMCO)
Vibration Isolation	Spring Isolators, All Purpose Mount, Neo-Spring, and Rubber Foam Pad	

TABLE OF CONTENTS

<u>ITEM</u>	<u>PAGE</u>
PLENUM SLOT DIFFUSER (5715I)	4
ROUND CEILING DIFFUSER (RNR)	5
SQUARE CEILING DIFFUSER (RNS)	6
ARCHITECTURAL CEILING DIFFUSER (UNI)	7
ALUMINUM SQUARE CEILING DIFFUSER (ARNS)	8
PERFORATED CEILING RETURNS (4360, 61PR, 4302)	9
DOUBLE DEFLECTION SIDEWALL SUPPLY REGISTER (61DVO)	10
LOUVERED RETURN AIR GRILLE / REGISTER (6145H)	11
EGGCRATE RETURN GRILLES (51EC)	12
FILTER GRILLES (51F)	13
SHEET METAL ADAPTERS & ROOF JACKS	14
GRILLE ACCESSORIES - DAMPERS, INSULATION, & PLASTER FRAMES	15
ACCESS DOORS	16 - 17
VIBRATION ISOLATION	18
ROOF SUPPORTS	19
SPIRAL DUCT AND FITTINGS	20 - 21
SNAPLOCK PIPE AND FITTINGS	22 - 24
DUCT HANGERS	25
FLEX DUCT	26
SHOP SUPPLIES - CORNERS, CLEATS, FLANGE, SLIP & DRIVE, DUCT SEAL, ETC.	27-28
FIELD SUPPLIES - THREADED ROD & STRUT, BEAM CLAMPS, TAPE, SCREWS	29-30
LOCATION MAP - DIRECTIONS	31

ROUND CEILING DIFFUSER

MODEL : RNR

- * Spun steel construction
- * Three concentric cones
- * Two horizontal discharge patterns
- * Removable inner core
- * Designed for exposed duct or hard ceilings
- * White powder coat finish

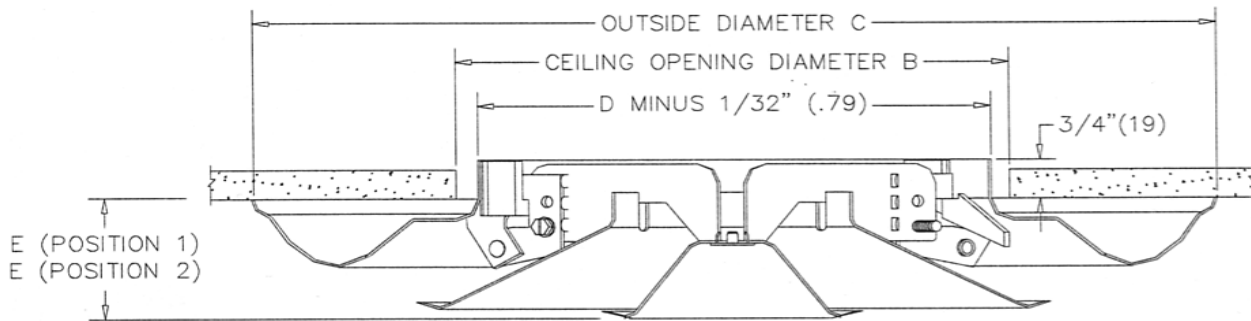

DIMENSIONAL DATA (inches)				DIFFUSER PRICE
NECK SIZE	C	E1	E2	
6"	11 5/8	1 1/8	1 3/4	
8"	14 3/8	1 1/2	2 1/8	
10"	17 15/16	2 1/8	2 7/8	
12"	21 5/8	2 3/8	3 1/8	
14"	25 1/4	2 5/8	3 3/8	

4250 RADIAL DAMPER

Ceiling Opening B = Duct Diameter + 1/2"

SQUARE CEILING DIFFUSER

MODEL : RNS3

- * Steel construction
- * High performance 360 degree diffusion
- * Square face
- * Round neck
- * Louvered 3-cone (standard) & 4-cone (available)
- * Removable core
- * White powder coat finish

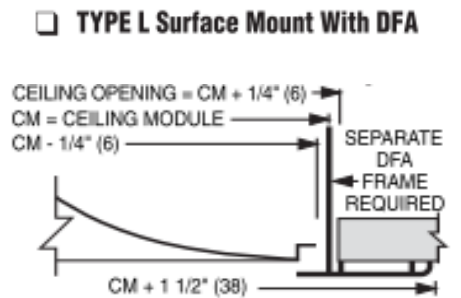
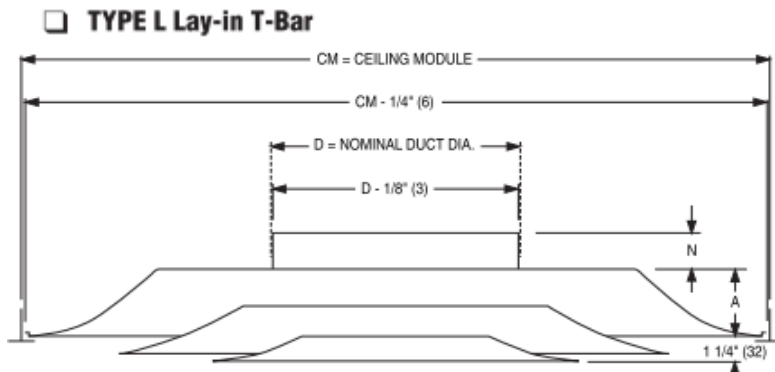
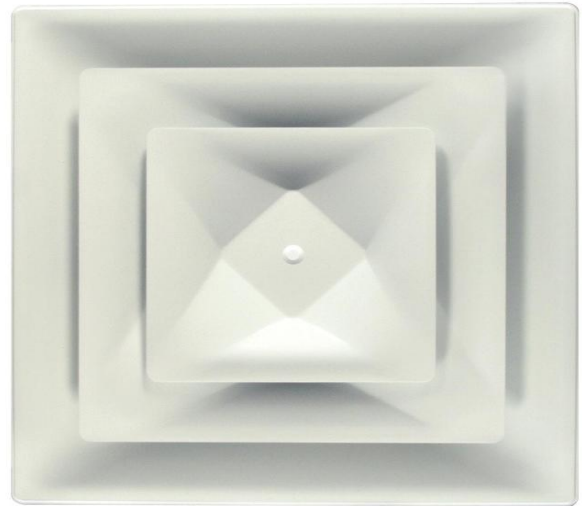

PANEL SIZE	ROUND NECK	DIFFUSER PRICE
24 X 24	6"	
	8"	
	10"	
	12"	
	14"	
12 X 12	6"	

SURFACE MOUNT FRAME

4250 DAMPER	
6"	
8"	
10"	
12"	
14"	

ARCHITECTURAL CEILING DIFFUSER

MODEL : UNI2

- * Steel construction
- * High performance
- * Square plaque face
- * Round neck
- * Removable inner core
- * 360 degree diffusion
- * White powder coat finish



TYPE L Lay-in T-Bar

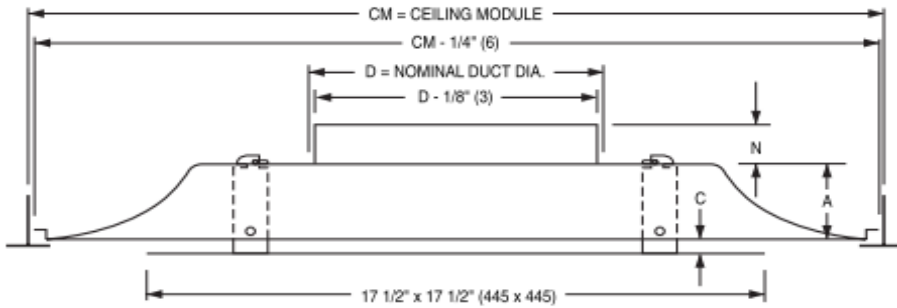

TYPE L Surface Mount With DFA

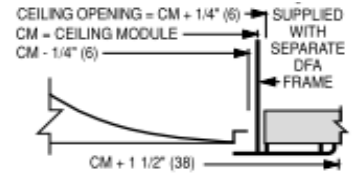

PANEL SIZE	ROUND NECK	DIFFUSER PRICE
24 X 24	6"	
	8"	
	10"	
	12"	
12 X 12	6"	
	8"	

SURFACE MOUNT FRAME

4250 DAMPER	
6"	
8"	
10"	
12"	
14"	

ALUMINUM SQUARE CEILING DIFFUSER

MODEL : ARNS3

- * Aluminum construction
- * High performance
- * Square face
- * Round neck
- * Louvered 3-cone diffuser
- * 360 degree diffusion
- * White powder coat finish

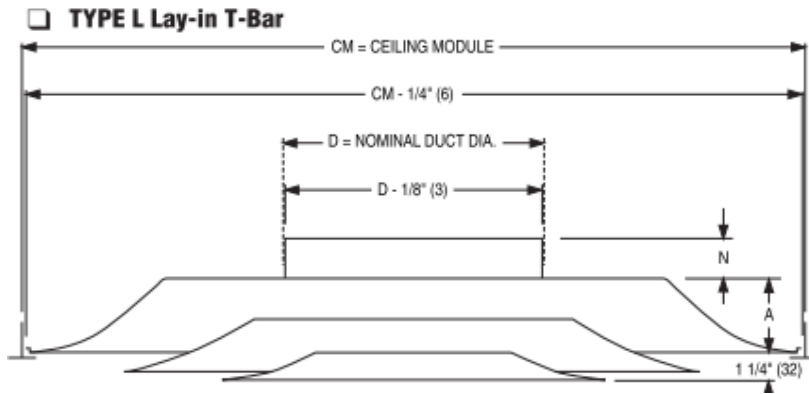
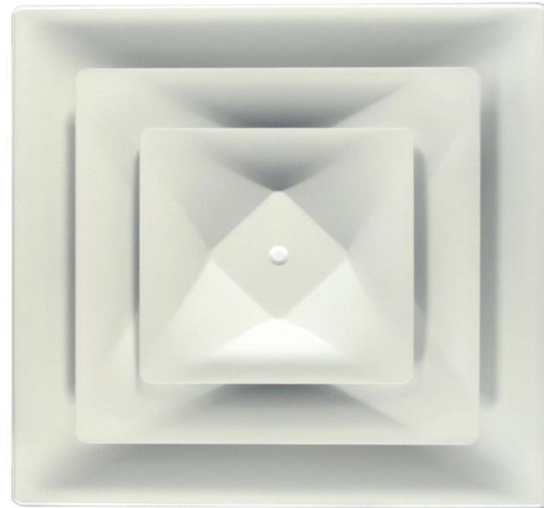

TYPE L Surface Mount With DFA

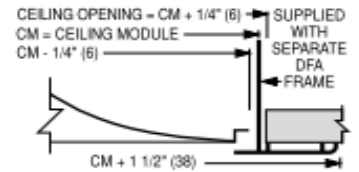

PANEL SIZE	ROUND NECK	DIFFUSER PRICE
24 X 24	6"	
	8"	
	10"	
	12"	
	14"	

SURFACE MOUNT FRAME

4250 DAMPER	
6"	
8"	
10"	
12"	
14"	

DOUBLE DEFLECTION SIDEWALL SUPPLY REGISTER

MODEL : 61DV-O

- * Steel construction
- * Double deflection
- * Adjustable vertical front blades
- * Adjustable horizontal rear blades
- * Opposed blade damper
- * Face size 1-3/4" larger than neck size listed
- * White powder coat finish

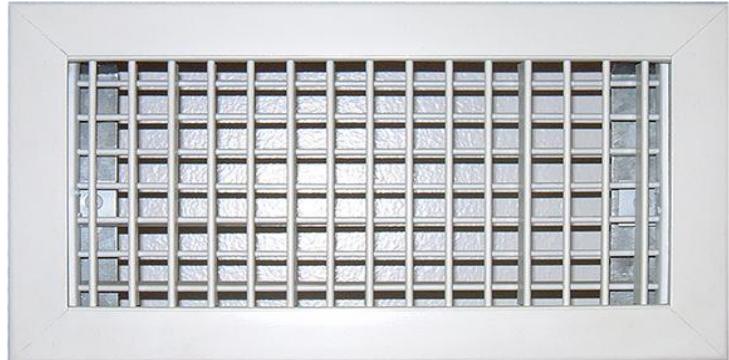

SIZE (W X H)	PRICE
6 X 4	
6 X 6	
8 X 4	
8 X 6	
8 X 8	
10 X 4	
10 X 6	
10 X 8	
10 X 10	
12 X 4	
12 X 5	
12 X 6	
12 X 8	
12 X 10	
12 X 12	
14 X 4	
14 X 5	
14 X 6	
14 X 8	
14 X 10	

SIZE (W X H)	PRICE
14 X 14	
16 X 4	
16 X 6	
16 X 8	
16 X 10	
16 X 16	
18 X 4	
18 X 6	
18 X 8	
18 X 10	
18 X 12	
18 X 14	
18 X 16	
20 X 4	
20 X 6	
20 X 8	
20 X 10	
20 X 12	
22 X 6	
22 X 10	

SIZE (W X H)	PRICE
24 X 4	
24 X 6	
24 X 8	
24 X 10	
24 X 12	
24 X 14	
24 X 16	
30 X 6	
30 X 8	
30 X 10	
30 X 12	
30 X 14	
30 X 16	
36 X 6	
36 X 8	
36 X 10	
36 X 12	
36 X 14	
36 X 16	

SIDEWALL RETURN AIR GRILLE

MODEL : 6145H

- * Steel construction
- * Horizontal fixed deflection vanes
- * Opposed blade damper available for some sizes
- * Face size 1-3/4" larger than neck size listed
- * White powder coat finish



SIZE (W X H)	PRICE
6 X 4	
6 X 6	
8 X 4	
8 X 6	
8 X 8	
10 X 6	
10 X 8	
10 X 10	
12 X 6	
12 X 8	
12 X 10	
12 X 12	
12 X 24	
14 X 6	
14 X 8	
14 X 10	
14 X 12	
14 X 14	
16 X 6	
16 X 8	
16 X 10	
16 X 12	
16 X 14	
16 X 16	
18 X 6	
18 X 8	
18 X 10	
18 X 12	

SIZE (W X H)	PRICE
18 X 14	
18 X 16	
18 X 18	
18 X 30	
18 X 36	
20 X 6	
20 X 8	
20 X 10	
20 X 12	
20 X 14	
20 X 20	
20 X 25	
24 X 6	
24 X 8	
24 X 10	
24 X 12	
24 X 14	
24 X 16	
24 X 18	
24 X 24	
24 X 30	
24 X 36	
24 X 48	
25 X 20	
30 X 6	
30 X 8	
30 X 10	
30 X 12	

SIZE (W X H)	PRICE
30 X 14	
30 X 16	
30 X 18	
30 X 24	
30 X 30	
36 X 6	
36 X 8	
36 X 10	
36 X 12	
36 X 14	
36 X 16	
36 X 18	
36 X 24	
36 X 36	
48 X 24	
48 X 30	
48 X 36	

LAY-IN GRILLES (NO SCREW HOLES)	
SIZE (W X H)	PRICE
10* X 10*	
22* X 10*	
22* X 22*	
46* X 22*	

*add 2" for ceiling module size

EGGCRATE RETURN GRILLES

MODEL : 51ECL / 51ECS / ECC

- * Available in lay-in / 12x12 surface mount / plastic core only
- * Aluminum core / Aluminum frame (51ECL 51ECS)
- * Plastic core only, available in white

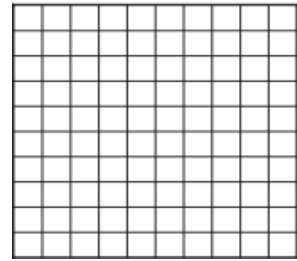
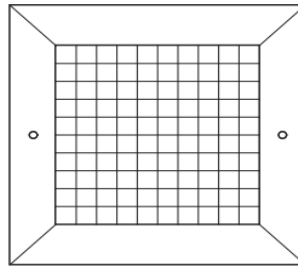
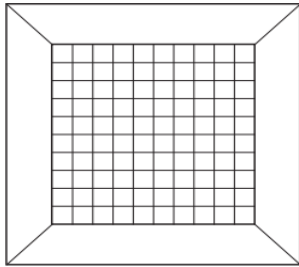
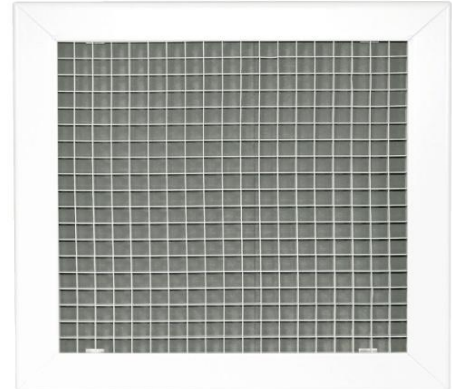

MODEL	FRAME	NECK	PANEL	CORE DIM.	PRICE
51ECL	L/I	10 X 10	12 X 12	1/2"X1/2"X1/2"	
		22 X 10	24 X 12		
		22 X 22	24 X 24		
		46 X 22	48 X 24		
51ECS	S/M	12 X 12	14 X 14	1/2"X1/2"X1/2"	
ECC-P	Core Only	N/A	24 X 12	1/2"X1/2"X1/2"	
			24 X 24		
			48 X 24		

NOTE
LAY-IN
LAY-IN
LAY-IN
LAY-IN
SCREW HOLES
PLASTIC CORE
PLASTIC CORE
PLASTIC CORE

FILTER GRILLES

- * Aluminum construction
- * Horizontal blade
- * Frames for 1" filters
- * Lay-in
- * Knurled knob / Latch fasteners
- * White powder coat finish



NECK SIZE	FACE SIZE	MODEL	TYPE	PRICE
20 X 8	24 X 12	51FB45-L	Louvered Face Lay-in	
20 X 20	24 X 24			

SHEET METAL ADAPTERS

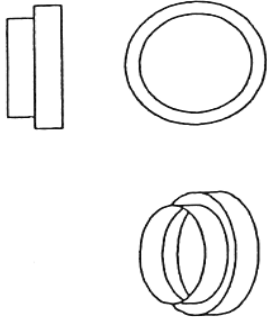

Round to Round Reducing (RRA)		
MODEL	SIZE	PRICE
6 RRA 4	6" TO 4"	
6 RRA 5	6" TO 5"	
8 RRA 6	8" TO 6"	
8 RRA 7	8" TO 7"	
10 RRA 8	10" TO 8"	
12 RRA 8	12" TO 8"	
12 RRA 10	12" TO 10"	
14 RRA 12	14" TO 12"	
15 RRA 14	15" TO 14"	
16 RRA 14	16" TO 14"	
16 RRA 15	16" TO 15"	

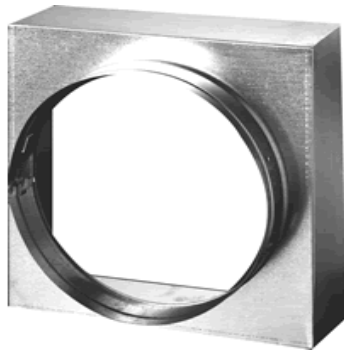

Square to Round Reducers (SRA)		
MODEL	SIZE	PRICE
8X8 SRA 6	8X8 TO 6"	
10X10 SRA 6	10X10 TO 6"	
10X10 SRA 8	10X10 TO 8"	
12X12 SRA 6	12X12 TO 6"	
12X12 SRA 8	12X12 TO 8"	
12X12 SRA 10	12X12 TO 10"	
20X20 SRA 12	20X20 TO 12"	
20X20 SRA 14	20X20 TO 14"	
20X20 SRA 16	20X20 TO 16"	
20X20 SRA 18	20X20 TO 18"	
20X20 SRA 20	20X20 TO 20"	
22X10 SRA 6	22X10 TO 6"	
22X10 SRA 8	22X10 TO 8"	
22X10 SRA 10	22X10 TO 10"	
22X22 SRA 6	22X22 TO 6"	
22X22 SRA 8	22X22 TO 8"	
22X22 SRA 10	22X22 TO 10"	
22X22 SRA 12	22X22 TO 12"	
22X22 SRA 14	22X22 TO 14"	
22X22 SRA 16	22X22 TO 16"	
22X22 SRA 18	22X22 TO 18"	



Roof Jacks - Cone Flashings		
MODEL	DUCT DIA.	PRICE
CF04-0/12	4"	
CF06-0/12	6"	
CF08-0/12	8"	
CF10-0/12	10"	
CF12-0/12	12"	

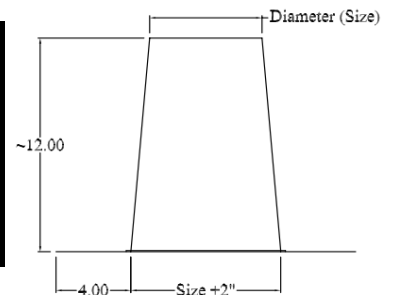

GRILLE & DIFFUSER ACCESSORIES

RADIAL SLIDING DAMPER

Model : 4250

- * Steel construction / Cost efficient volume control
- * Mounts directly to diffuser collar



NECK SIZE	PRICE
6"	
8"	
10"	
12"	
14"	

MOLDED INSULATION BLANKET

Model : MIB

- * Fits 24x24 round neck diffusers * R-6

SIZE	PRICE
24 x 24	

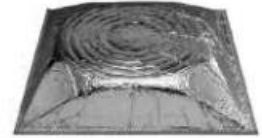

DUCTBOARD BACK

Model : DBB

- * Fits 22X10 or 22x22 square neck * 6" high (I.D.)

SIZE	PRICE
24 x 12	
24 x 24	



AUXILIARY FRAMES

Models : DFA

- * Hard ceiling frames for plaster and sheetrock ceilings

MODEL	SIZE	PRICE
4824 DFA	48 X 24	
2424 DFA	24 X 24	
2412 DFA	24 X 12	
1212 DFA	12 X 12	

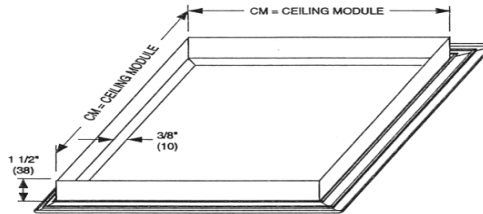

Models : RB - RADIAL BLADE DAMPER

- * Galvannealed steel - Singular comprehensive unit
- * Male 1/4" square twist cable end
- * 6ft cable lengths (longer available - made to order)

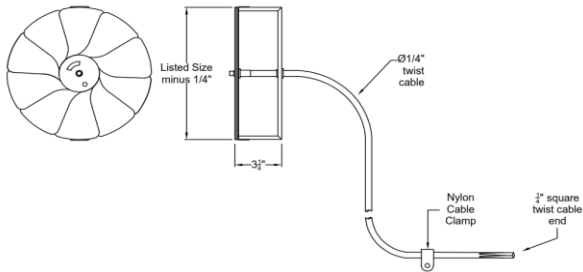

NECK SIZE	PRICE
6"	
8"	
10"	
12"	
14"	

ACCESS DOOR PRODUCTS

FIRE RATED ACCESS PANEL

Model : BIT - K

- * Steel construction and prime coat
- * UL Listed 1 1/2 hour rated for 2 hour fire walls
- * Full length hinges and constant force closure springs

SIZE	PRICE
12 X 12	
16 X 16	
18 X 18	
24 X 24	



ALL PURPOSE ACCESS PANEL

Model : BNT-C

- * Steel construction and prime coat
- * For drywall, plastered and masonry surfaces
- * Full length hinges and screwdriver cam latch

SIZE	PRICE
8 X 8	
12 X 12	
16 X 16	
18 X 18	
24 X 24	



ALL PURPOSE STAINLESS STEEL ACCESS PANEL

Model : BNT - C - SS

- * All stainless steel construction version of CNT - C

SIZE	PRICE
12 X 12	
18 X 18	
24 X 24	

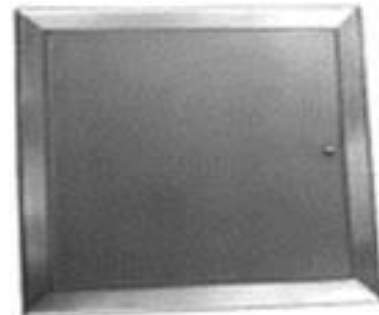

DUCT ACCESS DOOR PRODUCTS

RECTANGULAR DUCT ACCESS DOOR

Models : CAD & HAD

- * Double wall galvanized steel construction
- * 1" thick insulated, dual gasketing
- * Peening method installation
- * CAD - Removable door (paired camlocks)
- * HAD - Full length hinge and cammed operated latch

SIZE	PRICE
6 X 6	
8 X 8	
10 X 10	
12 X 12	
14 X 14	
16 X 16	
18 X 18	
24 X 24	



CAD - CAMLOCK

HAD - HINGED

ROUND DUCT ACCESS DOOR

Model : RAD

- * 20 guage galvanized steel construction
- * Insulated
- * Gasketed - 20" w.g.
- * Door size = (6", 8", 10") 8 x 4 oval / (Other Sizes) 12 x 8 oval
- * Easy installation and easy access

DUCT DIAMETER	PRICE
6"	
8"	
10"	
12"	
14"	
16"	
18"	
20"-24"	



VIBRATION ISOLATION

SPRING ISOLATORS

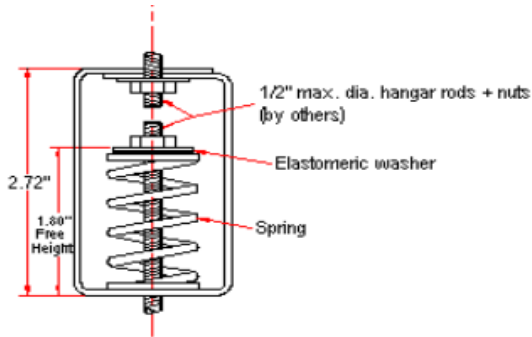

MODEL	SIZE	PRICE
VIHSS021	25 LB HANGING SPRING	
VIHSS022	44 LB HANGING SPRING	
VIHSF044	90 LB HANGING SPRING	
VIHSS024	125 LB HANGING SPRING	
VIHSA124	173 LB HANGING SPRING	

* Spring elements color-coded for easy field verification

* Load distribution steel washer

ALL PURPOSE HANGER MOUNT

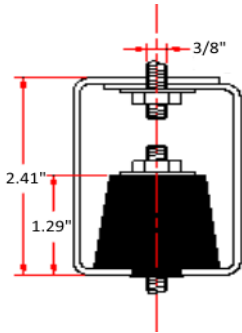

MODEL	SIZE	PRICE
VIAPHA1	95 LB HANGING RUBBER	
VIAPHA2	120 LB HANGING RUBBER	

* Element incorporates projected collar to prevent metal to metal contact between rod and bracket.

* Embedded steel plates on top of element for uniform loading.

* Oil + water resistant element

NEO-SPRING HANGER

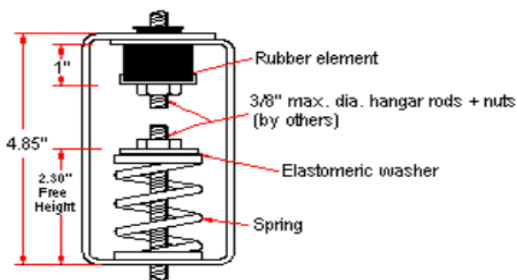

MODEL	SIZE	PRICE
VIHSNF-HM044	100 LB NEO-SPRING HANGER	

* Oil + water resistant rubber element

* Rubber element incorporates projected collar to prevent metal to metal contact between rod and bracket.

RUBBER FOAM PAD

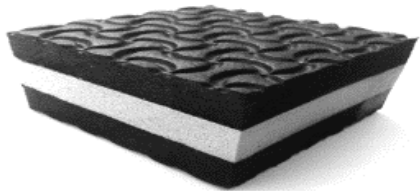

MODEL	SIZE	PRICE
VIRFP030301	3" X 3" X 1" VIBRATION PAD GREEN	
VIRFP060601	6" X 6" X 1" VIBRATION PAD GREEN	

* Material: Closed cell, chemically cross-linked high density rubber foam.

* Maximum loading: 70 lbs/sq.in.

* Working range: 15 to 60 lbs/sq.in.

ROOF SUPPORTS

RAW RUBBER BLOCK *strut not included

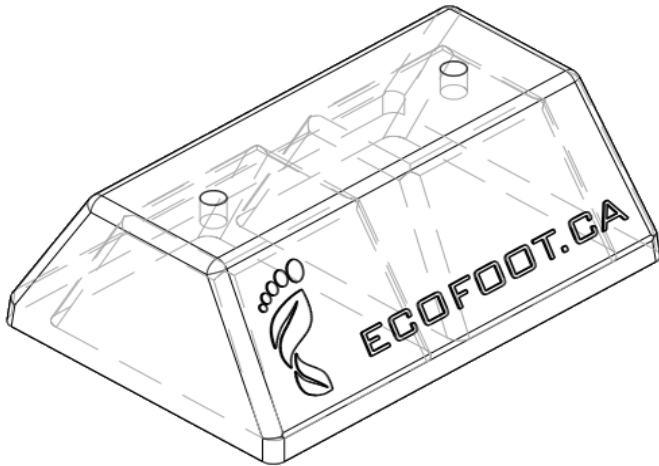

DESCRIPTION	PRICE
9" RUBBER BLOCK	

- * Accommodates standard 1-5/8" strut
- * UV stabilized for long lasting support.
- * USA Standard ASTM F1292-99.
- * Support a load of 100 lbs per block
- * Multiple blocks can be combined for greater weight dispersion.

ECOFOOT QUICK FRAME - H FRAME *strut not included

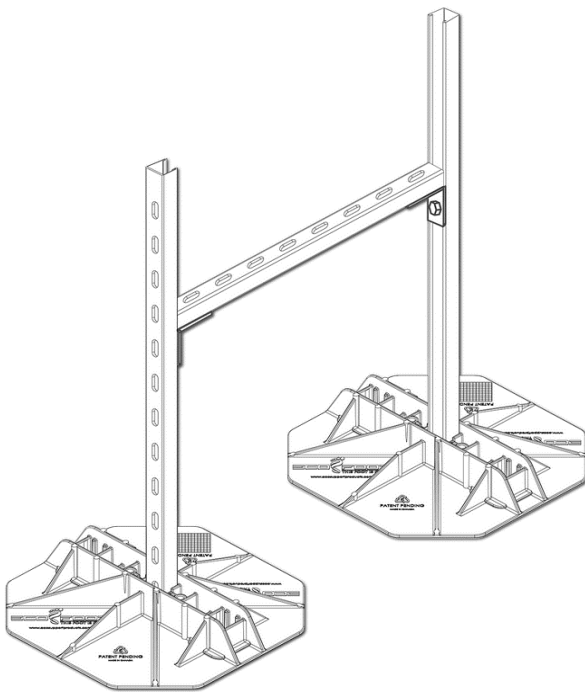

DESCRIPTION	PRICE
12" X 12" H FRAME	
18" X 18" H FRAME	

Each kit includes:

- (2) Injection moulded feet
- (2) Anti-vibration mats
- (2) Strut base caps
- (2) 90° strut brackets
- (4) Spring nuts
- (4) 1/2" bolts

- * Accommodates standard 1/2" threaded rod, or 1-5/8" strut
- * Customize required support on site
- * Keeps the roofing membrane safe and decking/insulation below free of damage.

SPIRAL DUCT AND FITTINGS

SPIRAL DUCT AND FITTINGS

* Slip Fittings

* Pipe prices can change at any time. Please confirm with your sales team.

* SMACNA Gauges

*LONG RADIUS STANDARD

STAMPED

SPIRAL SEAM

SESP

SEAHE90

SEAHE45

SESE90

SESE45

EMPCPL

EMPLUG

SEDPR**



DIA.	10' SPIRAL DUCT	90° ELB	45° ELB	90° ELB	45° ELB	COUPLING	PLUG	MANUAL DAMPER
4"								
5"								NS
6"								
8"								
10"								
12"								
14"								
16"		NS	NS					
18"		NS	NS					
20"		NS	NS					
22"		NS	NS					NS
24"		NS	NS					NS
26"	*	NS	NS	NS	NS	NS	NS	NS
28"	*	NS	NS	NS	NS	NS	NS	NS
30"	*	NS	NS	NS	NS	NS	NS	NS

*Sizes not stocked, but fabricated in house

**With 2" stand off

Short Radius Elbows		
DIA.		45° ELB
6"		
8"		
10"		
12"		
14"		

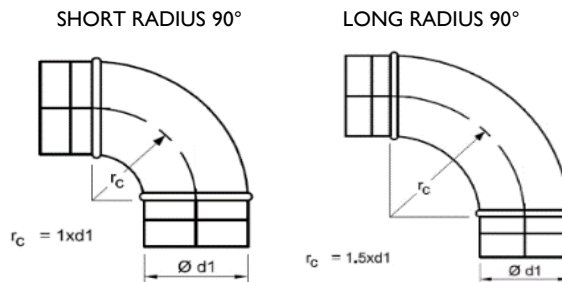

SPIRAL DUCT AND FITTINGS

SPIRAL DUCT AND FITTINGS (CONT.)

EMPST



EMPSR



SADDLE TAPS			
4" TAP TO MULTI-ROUND		16" TAP 16" BODY	
6" TAP 6" BODY		16" TAP TO MULTI-ROUND	
6" TAP TO MULTI-ROUND		18" TAP 18" BODY	
8" TAP 8" BODY		18" TAP TO MULTI-ROUND	
8" TAP TO MULTI-ROUND		20" TAP 20" BODY	
10" TAP 10" BODY		20" TAP TO MULTI-ROUND	
10" TAP TO MULTI-ROUND		22" TAP 22" BODY	
12" TAP 12" BODY		22" TAP TO MULTI-ROUND	
12" TAP TO MULTI-ROUND		24" TAP 24" BODY	
14" TAP 14" BODY		24" TAP TO MULTI-ROUND	
14" TAP TO MULTI-ROUND			

SPUN REDUCERS	
SPUN REDUCER 6" TO 4"	
SPUN REDUCER 8" TO 6"	
SPUN REDUCER 10" TO 6"	
SPUN REDUCER 10" TO 8"	
SPUN REDUCER 12" TO 8"	
SPUN REDUCER 12" TO 10"	
SPUN REDUCER 14" TO 10"	
SPUN REDUCER 14" TO 12"	
SPUN REDUCER 16" TO 12"	
SPUN REDUCER 16" TO 14"	
SPUN REDUCER 18" TO 14"	
SPUN REDUCER 18" TO 16"	
SPUN REDUCER 20" TO 16"	
SPUN REDUCER 20" TO 18"	
SPUN REDUCER 22" TO 18"	
SPUN REDUCER 22" TO 20"	
SPUN REDUCER 24" TO 20"	
SPUN REDUCER 24" TO 22"	

DUCT MOUNTED REGISTERS

- * Supply/return register with adjustable double deflection blades and a volume damper/extractor.
- * Mounting directly on spiral duct
- * Register taps are not required

MODEL: RGS	
13" X 3"	
13" X 6"	
17" X 3"	
17" X 6"	
21" X 6"	

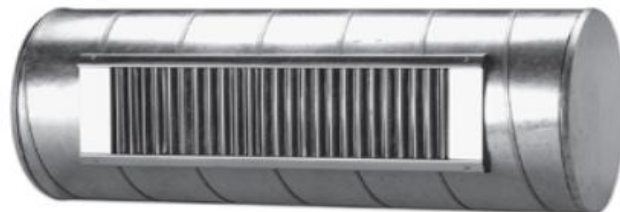

SNAP LOCK PIPE AND FITTINGS

SNAP LOCK PIPE AND FITTINGS

* Standard and SMACNA gauges available

* Many other taps and fittings available by special order

LPSLP



LPAELB



LPPLUG



LPRED



DIAMETER	5' PIPE SMACNA	5' PIPE 30GA
4"		
6"		
8"		
10"		
12"		
14"		
16"		
18"	NS	
20" (4'L)	NS	









ADJ. ELBOW SMACNA	ADJ. ELBOW 30GA	END CAP/ PLUG	REDUCER	PRICE
			6" TO 4"	
			8" TO 6"	
			10" TO 6"	
			10" TO 8"	
			12" TO 8"	
			12" TO 10"	
			14" TO 10"	
		NS	14" TO 12"	
		NS	16" TO 10"	
			16" TO 14"	

LPWYE









WYE	PRICE	WYE	PRICE	WYE	PRICE	WYE	PRICE
6" X 4" X 4"		12" X 6" X 6"		14" X 12" X 10"		18" X 14" X 12"	
6" X 6" X 6"		12" X 8" X 8"		14" X 12" X 12"		18" X 14" X 14"	
8" X 6" X 6"		12" X 10" X 8"		14" X 14" X 10"		18" X 16" X 10"	
8" X 8" X 6"		12" X 10" X 10"		14" X 14" X 12"		18" X 16" X 12"	
8" X 8" X 8"		12" X 12" X 8"		16" X 12" X 10"		18" X 16" X 16"	
10" X 6" X 6"		12" X 12" X 10"		16" X 12" X 12"		18" X 18" X 10"	
10" X 8" X 6"		12" X 12" X 12"		16" X 14" X 10"		18" X 18" X 12"	
10" X 8" X 8"		14" X 10" X 8"		16" X 14" X 12"		20" X 18" X 12"	
10" X 10" X 8"		14" X 10" X 10"		16" X 14" X 14"		20" X 18" X 16"	
10" X 10" X 10"		14" X 12" X 8"		16" X 16" X 16"			

LOW PRESSURE TAPS AND DAMPERS

TAP	Description	4"	6"	8"	10"	12"	14"	16"	18"	20"
ELPFS 	Damper Blade w/ Tips									NS
LPFSM 	Finger Saver Metal Duct	NS								
LPFSMD 	Finger Saver Metal Duct w/ Jiffy Damper	NS								
LPFS 	Finger Saver Ductboard	NS								
LPSPIN 	Spin-In Straight	NS						NS	NS	NS
LPSPINFSD 	Spin-In Straight w/ Damper	NS								NS
LPCONSPINFSD 	Conical Spin-In w/ Jiffy Damper	NS						NS	NS	NS
LPSPIND 	Conical Spin-In w/ Damper & Stand Off	NS								NS

LOW PRESSURE TAPS AND DAMPERS

<u>TAP</u>	<u>Description</u>	4"	6"	8"	10"	12"	14"	16"	18"	20"
	Damper Blade w/ 3/8" Rod	NS							NS	NS
	Conical Tap w/ Sticky Gasket	NS							NS	NS
	Conical Tap w/ Damper, Stand Off, & Sticky Gasket	NS								NS
	Straight Tap w/ Sticky Gasket	NS							NS	NS
	Straight Tap w/ Damper, Stand Off, & Sticky Gasket	\$20.30							NS	NS
	HETO w/ Sticky Gasket	NS							NS	NS
	HETO w/ Damper, Stand Off, & Sticky Gasket	NS							NS	NS

FLEX DUCT

Royal Model 901 Flexible Duct

* Designed for low to medium pressure systems

* R-6.0 & R-8.0 * 25' per bag

DIAMETER	R-6.0 PRICE	R-8.0 PRICE
4"		
5"		
6"		
7"		
8"		
9"		
10"		
12"		
14"		
16"		NS
18"		NS
20"		NS

* Pressure Rating: (WG):

Positive: 10 inches (4"-20" ID)

Negative: 3/4 inch (4"-20" ID)

FLEXFLOW ELBOWS	
6"-16"	



DUCT WEBBING	
1-3/4" X 300'	



Thermaflex Model MK-E Flexible Duct

* Suitable for all pressure heating and cooling systems

* Acoustical duct offers exceptional sound control

* R-6.0 * 25' per box

* Pressure Rating: (WG):

DIAMETER	PRICE
6"	
8"	
10"	
12"	
14"	
16"	
18"	

Positive: 10 inches (4"-12" ID), 6 inches (14"-16" ID)

Negative: 1 inch (4"-12" ID), 1/2 inch (14"-20" ID)

FLEXFLOW ELBOWS	
6"-16"	



DUCT WEBBING	
1-3/4" X 300'	



SHOP SUPPLIES

ELPSLIPFL110

Slip Flat "S" 24GA. 1" X 10FT



PRICE

ELPDRIVE110

Drive Material 1" 24GA. X 10FT



PRICE

ELPSLIPST110

Slip Standing "S" 24GA. 1" X 10FT

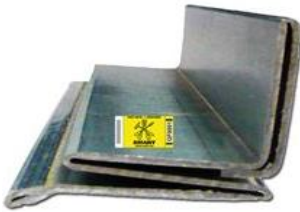

PRICE

ELPUCCORNER

Ultra C Stackable Corner Auto or Manual Insert
250 CT per box (112 box per skid)



PRICE/box

ELPJCORNER

J Corner - 250 CT



PRICE

ELPUCBOLT

Ultra Bolt with 5/16 drive head

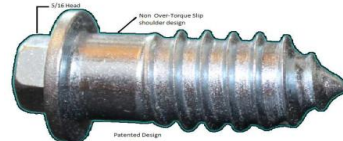

PRICE

ELPE55CLEAT

E-55 Cleat Metal for all flange - 250 CT



PRICE

ELPFCLEAT

Cleat for Elgen Flange Metal - 500 CT



PRICE

SHOP SUPPLIES (cont.)

ELPJANGLE20

J Angle *No Holes* - 20FT Joints



PRICE (ea)

ELPFANGLE20

Elgen Flange *No Holes* - 20FT Joints



PRICE (ea)

ELPRB3/8SQ

3/8"SQ Rubber Bushing - 100CT



PRICE

Neoprene Flex Connector
100FT / BOX



PRICE
<u>ELPZLN333</u> (3X3X3) -
<u>ELPZLN444</u> (4X4X4) -

ELP19GAMESH100

1/2 X 1/2 X 48" 19 GA Wire Mesh - 100FT



PRICE

ELP440BG

440 Butyl Gasket - 500FT (20 rolls of 25ft)



PRICE



ELPBLUE

Blue Shrink Wrap

(Blue & Red) 24" X 200FT - 3 MIL -
24" X 600FT - 3 MIL -
36" X 200FT - 3 MIL -

PRICE

ELPSTRAPSS

Stainless Steel Strap



PRICE (ea)	
6"	
8"	
10"	
12"	
14"-16"	

ELPLABEL

White Removable Labels - 1000CT(6 Labels per Sheet)

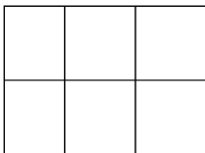

PRICE (ea)



ELPAE-88

Spary-On Edge Coating

PRICE (ea)

FIELD SUPPLIES

SCREWS



SIZE	PRICE
SPEED PT SCREW 1/2" #10 (1000 COUNT)	
SPEED PT SCREW 1/2" #10 (500 COUNT)	
SELF TAP SCREW 1/2" #10 (1000 COUNT)	
SELF TAP SCREW 1/2" #10 (500 COUNT)	
SPEED PT SCREW 3/4" #10 (1000 COUNT)	
SPEED PT SCREW 3/4" #10 (500 COUNT)	
SELF TAP SCREW 3/4" #10 (1000 COUNT)	
SELF TAP SCREW 3/4" #10 (500 COUNT)	

AIRSEAL, FIRE SEAL, BRUSHES



DESCRIPTION	PRICE
AIRSEAL 33 GREY 1 GALLON PAIL	
FIRE SEAL 10.5OZ TUBE FS-T	
2" PAINT BRUSH SB-2	

TAPE & PANDUIT STRAP



DESCRIPTION	PRICE
2" 450 FLEX FIT METALIC TAPE	
2.5" 2000 FOIL TAPE UL181A/B	
557 FLEX TAPE METALIC	
3" SCRIM TAPE FSK UL723	
PANDUIT STRAP 36" BAG OF 50	

DUCT WRAP

* R-6.0
* 75' per bag

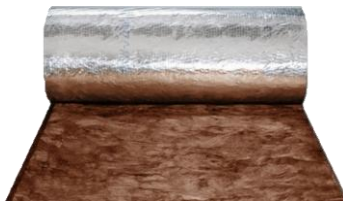

SIZE	PRICE
Duct Wrap - 2 1/8" X 48"	

STAPLES	PRICE
Power Crown Staples 1/2" 12mm - 5,000	
T6 Outward Clinch Stapler	

THREADED ROD & STRUT



THREADED ROD	PRICE
THREADED ROD 3/8" X 10'	



THREADED ROD ACC.	PRICE
3/8" HEX NUT - 100 CT	
3/8" WASHER FLAT - 100CT	
3/8" X 1" CARRIAGE BOLT - 50 CT	
3/8" DROP-IN ANCHOR (EA.)	
3/8" BEAM CLAMP (EA.)	



HANGING STRUT	PRICE
STRUT 1 5/8" X 10' (14GA)	
STRUT 1 5/8" X 20' (12GA)	
STRUT 13/16" X 20' (12GA)	



LOCATION MAP

COLLINS WALKER INC.

10900 GOODNIGHT LN. #130

DALLAS, TEXAS 75220

972-247-5433



Google Maps



Collins Walker Website



Apple Maps





TERMS AND CONDITIONS OF SALE

1. Prices are selling prices.
2. Payment terms are COD or net 30 days from date of invoice with approved credit.
3. Items to be returned to stock are subject to a 25% restocking fee.
4. All sales final on special orders, spiral pipe, snap lock pipe, and flex duct.
5. Warehouse warranties are standard manufacturers warranty.
6. Pricing is subject to change without notice.
7. Title to all material shall remain the sellers until the purchase is paid in full.
8. Claims : The respositibility of Collins Walker, Inc. ceases upon delivery of materials in good order to the carrier. Any claims for damages, shortages, or loss in transport must be filed by the customer against the transportation company. Claims of shortage will not be considered unless made within 30 days after receipt of goods.